

# Origin of the resting membrane potential

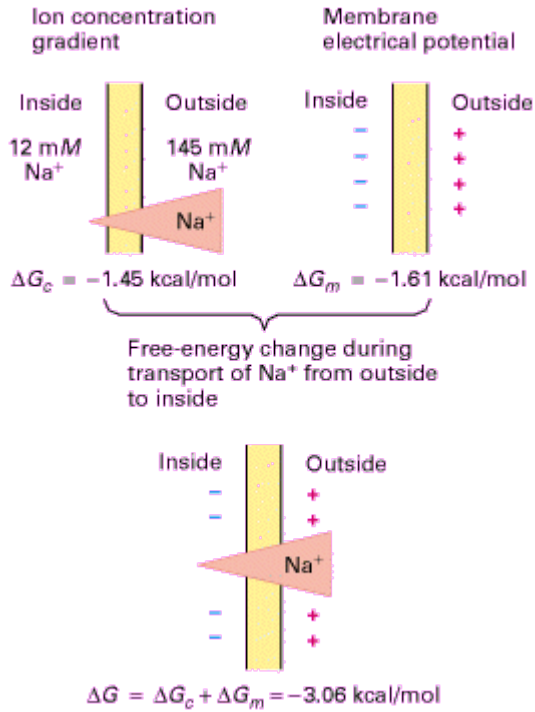

## *Nernst-equation:*

relationship between potential difference and ion concentration in equilibrium for one sort of ion

$$E = V_{IC} - V_{EC} = \frac{RT}{zF} \ln \frac{[C]_{EC}}{[C]_{IC}}$$

## *Goldman-Hodgkin-Katz-equation (GHK):*

resting membrane potential as a function of the ion concentrations and permeabilities

- more, independently moving ions
- constant electric force intensity through the
- membrane

$$V_{rest} = \frac{RT}{F} \ln \frac{P_K [K^+]_{EC} + P_{Na} [Na^+]_{EC} + P_{Cl} [Cl^-]_{IC}}{P_K [K^+]_{IC} + P_{Na} [Na^+]_{IC} + P_{Cl} [Cl^-]_{EC}}$$

## *Nernst-Planck equation:*

ionic flux (current) as a function of the electro-chemical potentials

# Basics of the conductance-based models

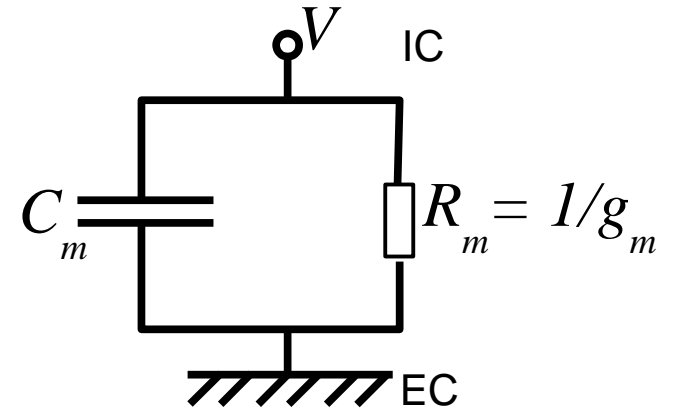
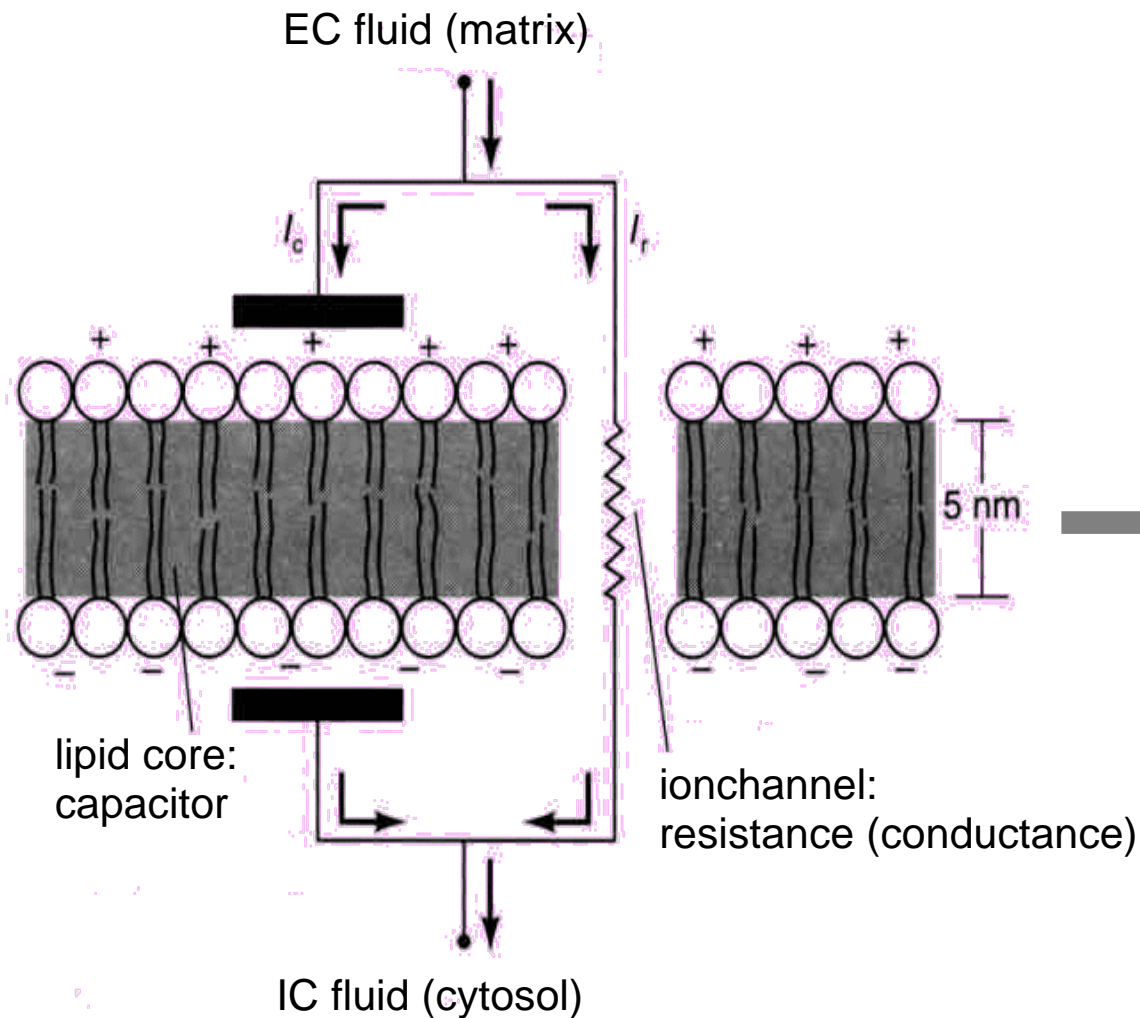

$$C_m \frac{dV(t)}{dt} = - \frac{V(t)}{R_m} = - V(t) g_m$$

capacitive current      resistive or conductive current

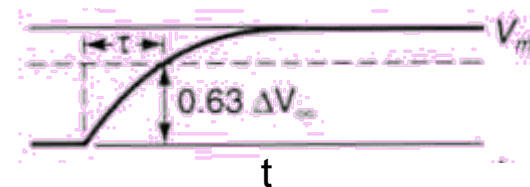

# Model with parallel conductances

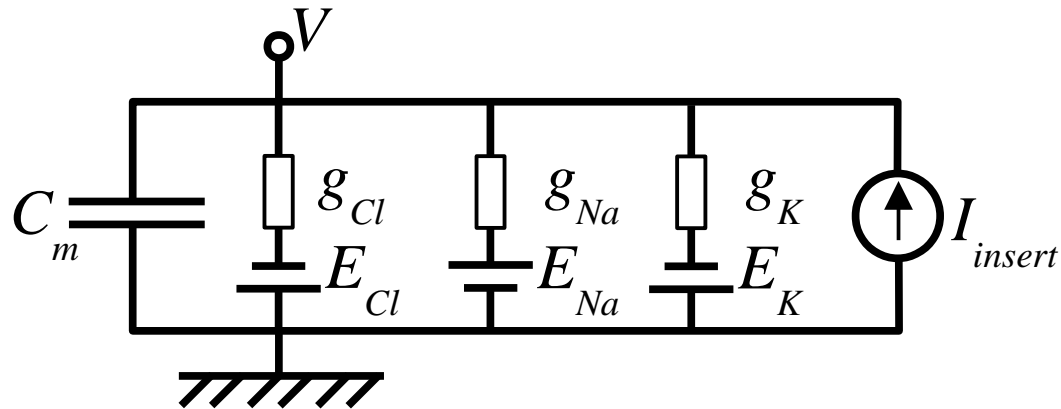

**Equation for current equilibrium:**

$$C_m \frac{dV(t)}{dt} = g_{Cl}(E_{Cl} - V(t)) + g_{Na}(E_{Na} - V(t)) + g_K(E_K - V(t)) + I_{insert}(t)$$

*Nernst-  
potential*

driving force

single ion current

# The Hodgkin-Huxley model / 1

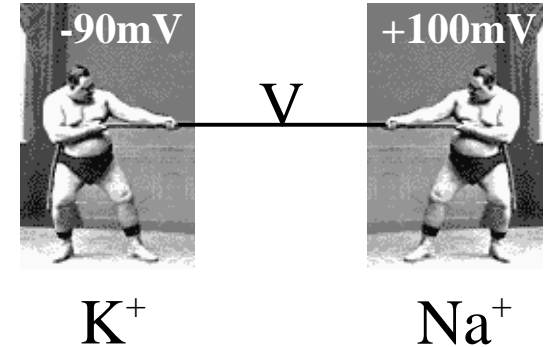
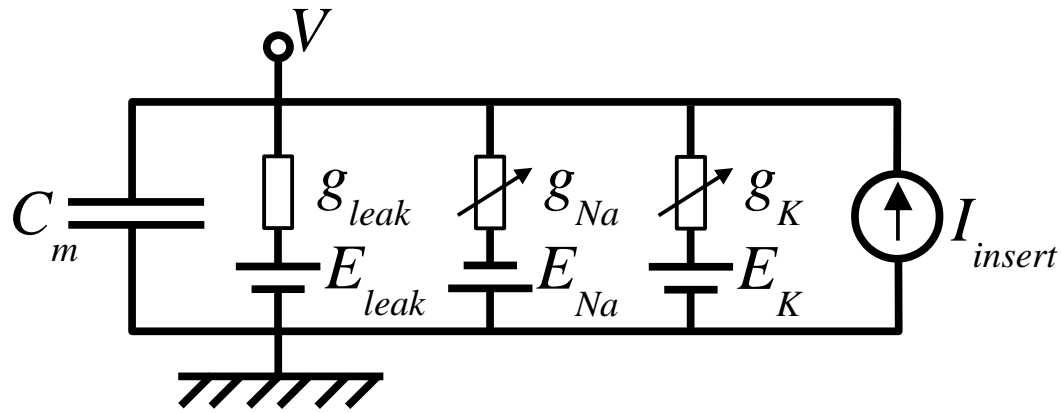

**Equation for current equilibrium:**

$$C_m \frac{dV(t)}{dt} = \underbrace{g_{leak} (E_{leak} - V(t))}_{\text{Leak current (mainly Cl}^-)} + g_{Na}(t) (E_{Na} - V(t)) + g_K(t) (E_K - V(t)) + I_{insert}(t)$$

**Equations for ionic currents:**

$$g_{Na}(t) = \bar{g}_{Na} \cdot m^3(t) \cdot h(t)$$

$$g_K(t) = \bar{g}_K \cdot n^4(t)$$

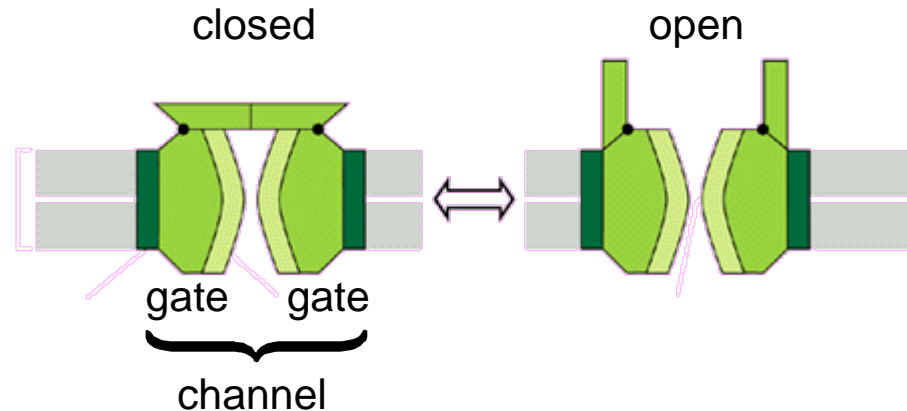

# The Hodgkin-Huxley model / 2

What is most important in the HH model: voltage dependent gating kinetics

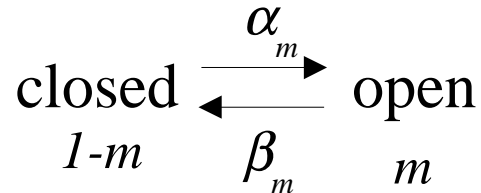

$$\frac{dm(t)}{dt} = \alpha_m(V(t))(1-m(t)) - \beta_m(V(t))m(t) = \frac{m_\infty(V(t)) - m(t)}{\tau_m(V(t))}$$

$$m_\infty(V) = \frac{\alpha_m(V)}{\alpha_m(V) + \beta_m(V)}$$

$$\tau_m(V) = \frac{1}{\alpha_m(V) + \beta_m(V)}$$

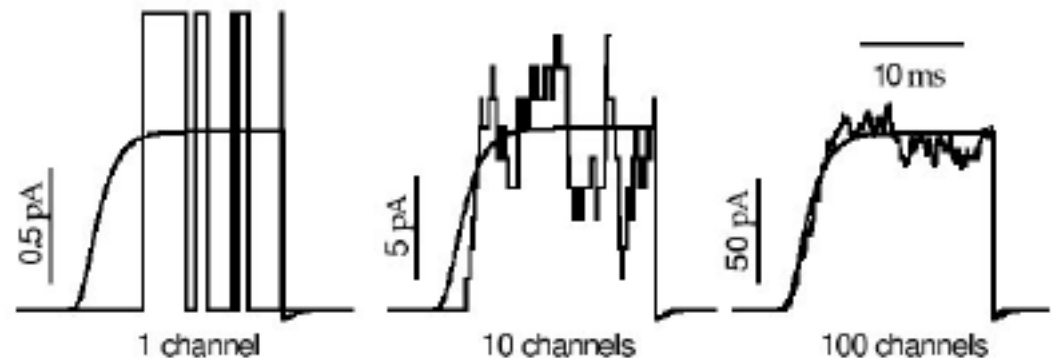
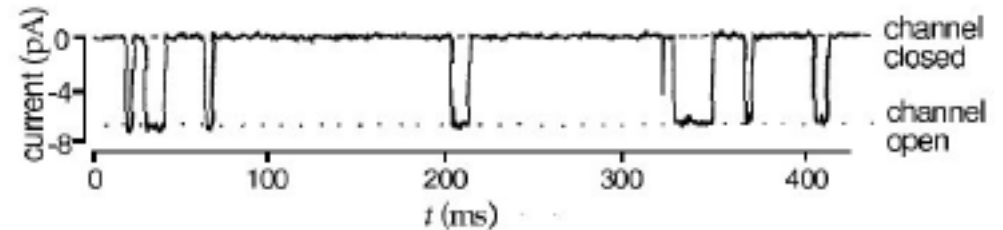

# The Hodgkin-Huxley model / 3

What is most important in the HH model: voltage dependent gating kinetics

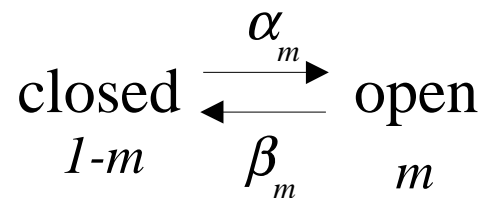

$$\frac{dm(t)}{dt} = \alpha_m(V(t))(1-m(t)) - \beta_m(V(t))m(t) = \frac{m_\infty(V(t)) - m(t)}{\tau_m(V(t))}$$

$$m_\infty(V) = \frac{\alpha_m(V)}{\alpha_m(V) + \beta_m(V)}$$

$$\tau_m(V) = \frac{1}{\alpha_m(V) + \beta_m(V)}$$

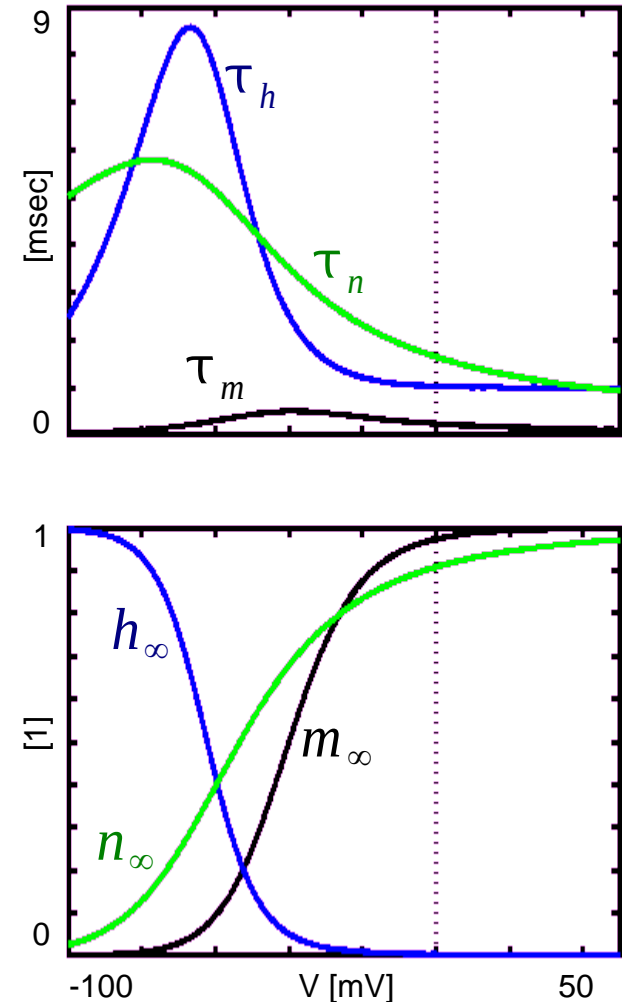
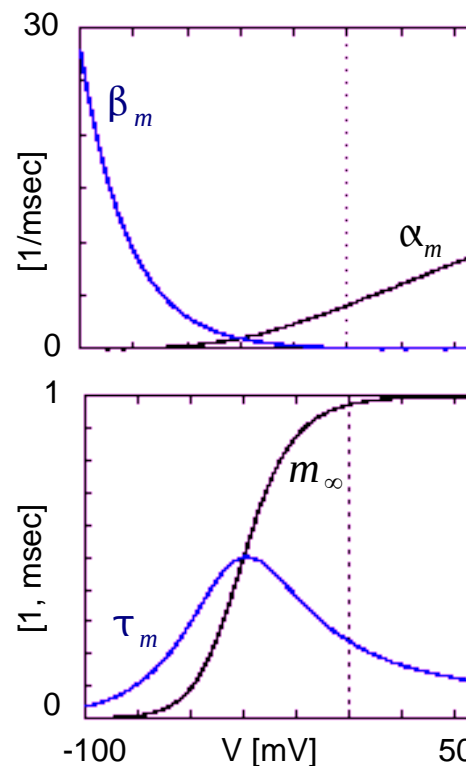

# The Hodgkin-Huxley model / 4

HH model in work:

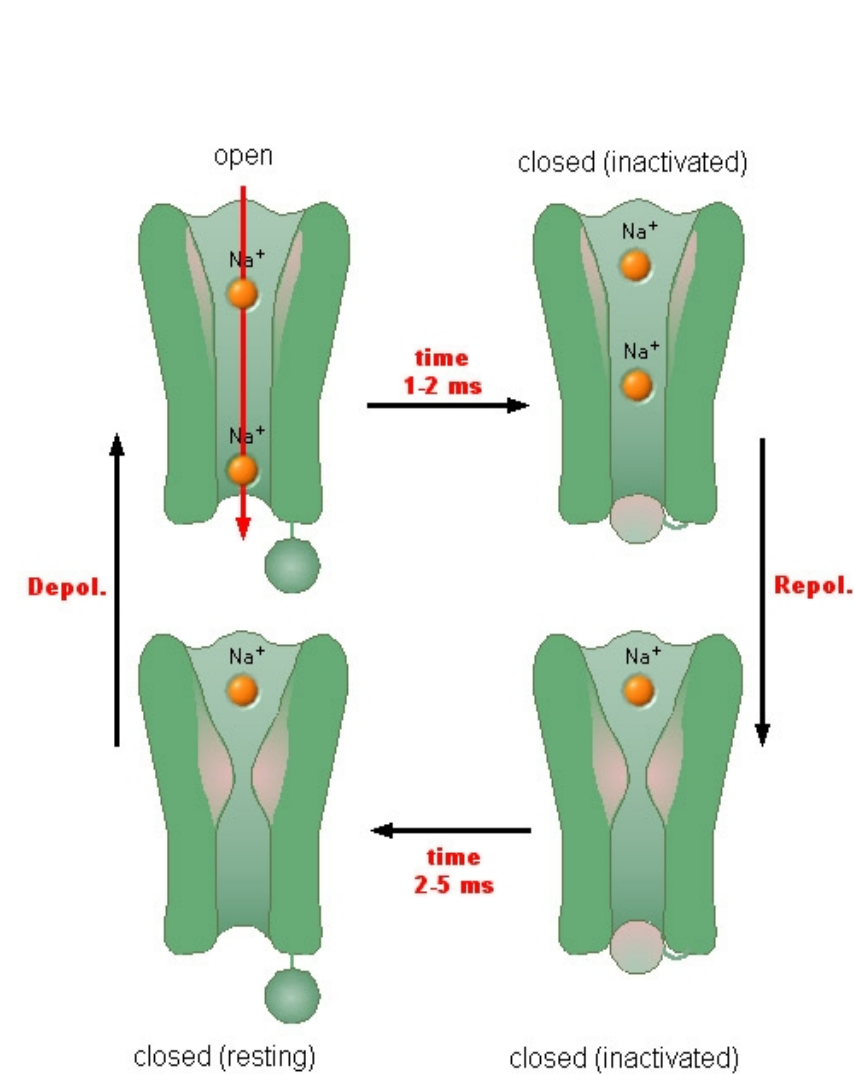
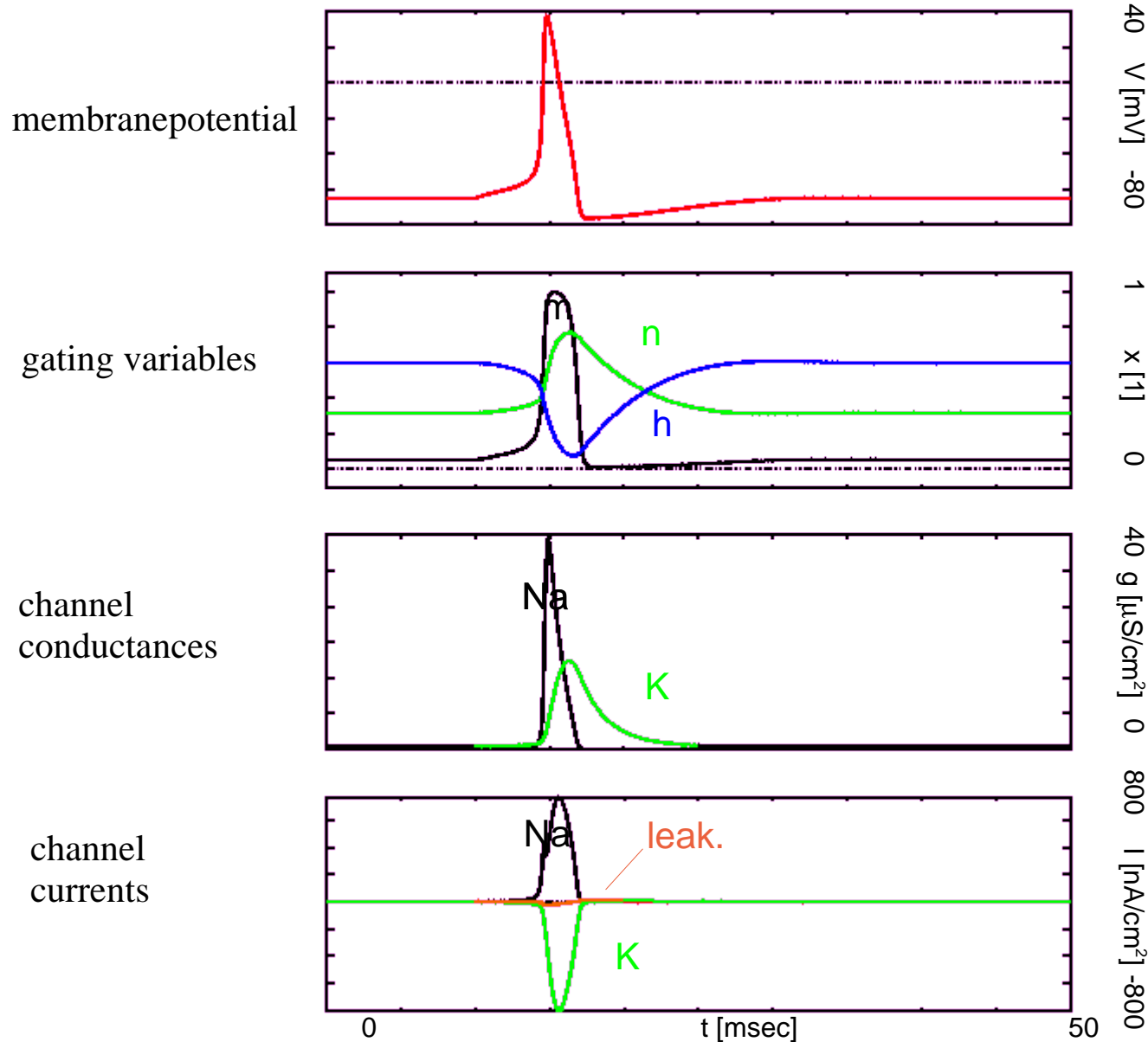

# The Hodgkin-Huxley model / 5

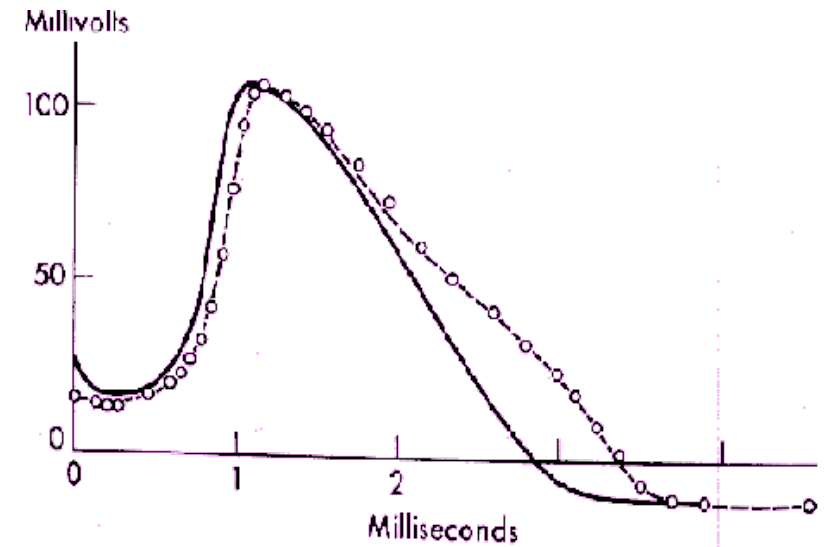

Sir John Carew Eccles, Alan Lloyd Hodgkin, Andrew Fielding Huxley: Awarded by Nobel-prize in medicine, 1963.

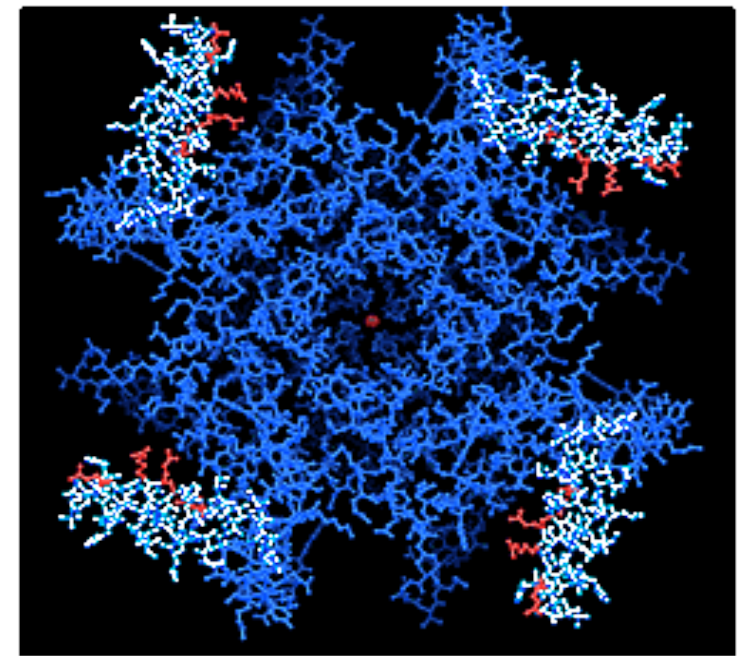
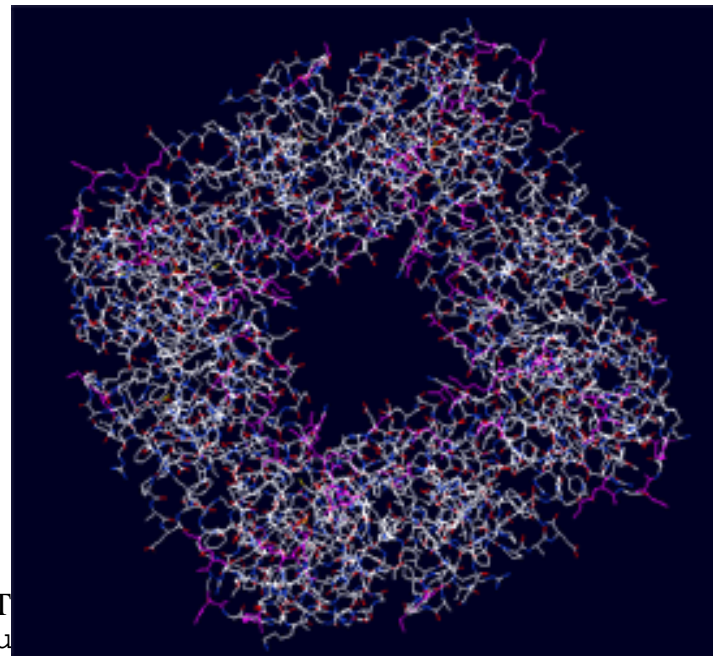
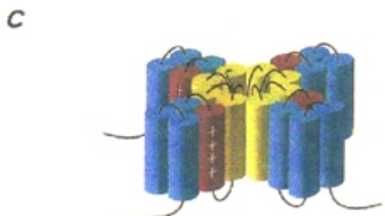
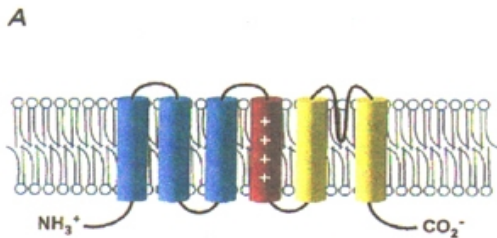



# The Hodgkin-Huxley model / 6

